

CUSTOM LIGHTING LTD.

M A N U F A C T U R I N G • D E S I G N • T E C H N O L O G Y

CL5N-S-NARROW (3') T5 Side Mount Strip

Engineered for one T5 fluorescent lamp, the CL5N-S-NARROW provides a cost-effective lighting solution for compact spaces such as under counters and within cabinets.

Housing built from 22 gauge pre-painted steel. The luminaire is powered by a small 120v electronic ballast. Standard 1/2" knock-outs are provided in each end of the fixture for ease of installation.

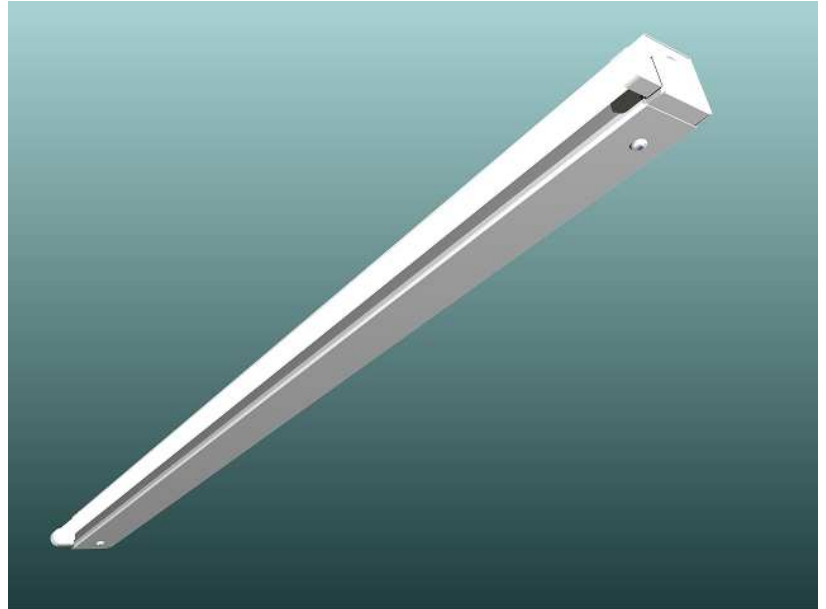

CL5N-S-NARROW (3')

All fixtures **CSA** approved.

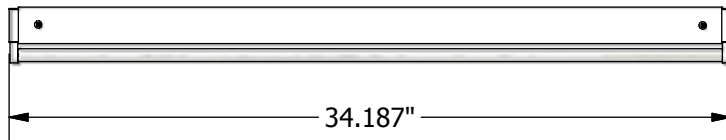

Length (1'): 12.062"
Length (2'): 22.375"
Length (4'): 46.000"
Length (8'): 92.000"

BOTTOM VIEW

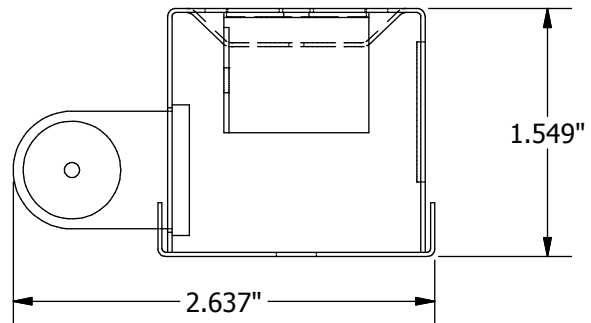

SIDE VIEW

Ordering Logic (Choose from available options)

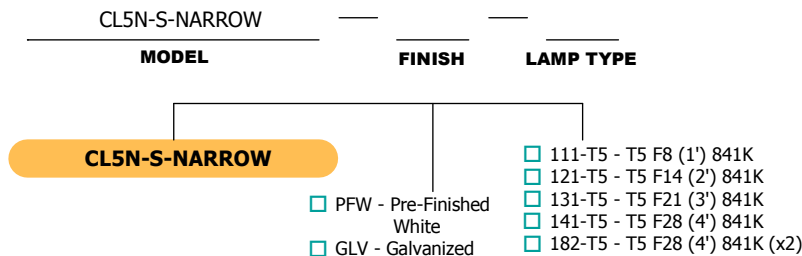

Custom Lighting Ltd. 7923 Coronet Road, Edmonton, AB, T6E 4N7
Tel: (780) 463-8014 Fax: (780) 463-2216 Email: sales@customlightingltd.com www.customlightingltd.com